

## For ceiling light

### HD401V

1. 5.8GHz microwave motion sensor with dimmable function.
2. Suitable for Ceiling lights or Bulkhead.
3. Loop in and loop out for easy installation.
4. Sensitive and reliable
5. 3 year limited warranty.

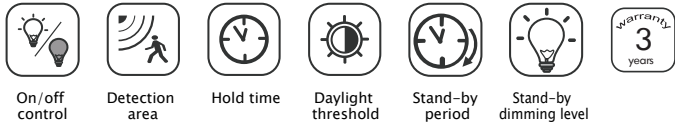

### Detection coverage

This figure indicates the maximum distance at the highest mounting height with 100% sensitivity. Typical installation height 2.5-6m

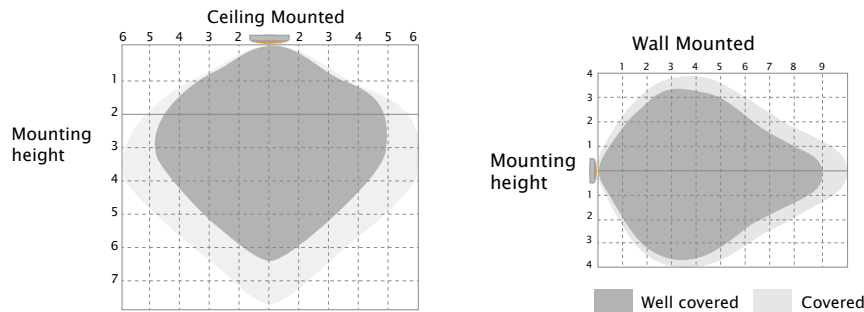

### Technical data

Operating voltage	120-277VAC, 50Hz/60Hz
Switching capacity	Max, 3.0A@120Vac, 50/60Hz; Max, 2.0A@277Vac, 50/60Hz
Stand-by power	≤1W
Control method	On/off / 1-10V Dimming
Microwave frequency	5.8GHz±75MHz
Microwave power	<0.3mW
Detection area	10%/50%/75%/100%
Hold time	5s/30s/1min/5min/10min/20min/30min
Daylight threshold	2Lux/10Lux/50Lux/Disable
Stand-by period	0s/10s/1min/10min/30min/1H/∞
Stand-by dimming level	10%/20%/30%/50%
Mounting height	2.5-6m / 8.2-19.68ft
Detection range	Max.∅14m/45.93ft
Motion detection	0.5~1.5m/s
Operating temperature	-20°C~+55°C
IP rating	IP20
Warranty	3 years

Factory Default Setting: Detection area 100%/ Hold time 5s/ Daylight threshold Disable/ Stand-by period 0s/ Stand-by dimming level 10%.

### Mechanical structure

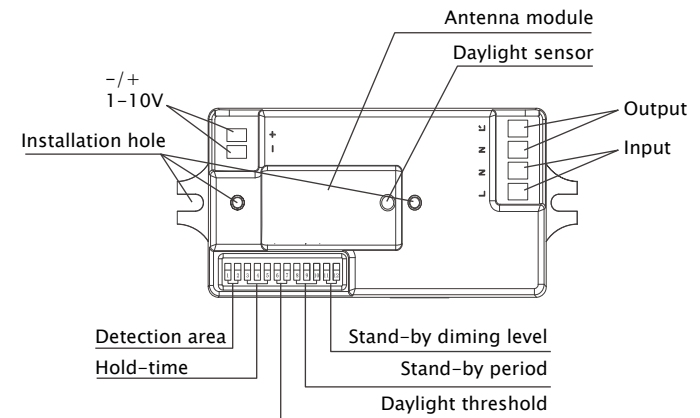

## Dimensions (Unit: mm)

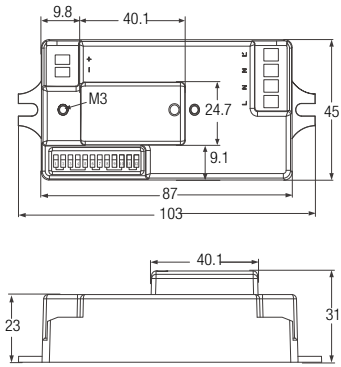

## Wiring diagram

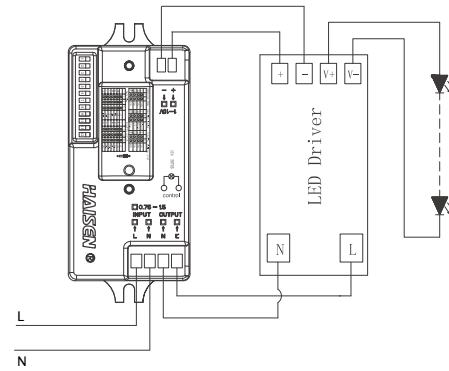

## Application

### 1. Automatically ON/OFF function:

Light on when detect movement and off after people leave at night. Applications: Corridor, Staircase.

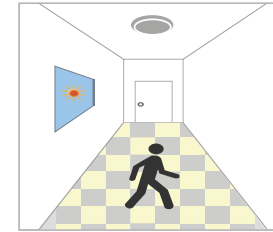

With sufficient daylight, even when motion detected, light remains OFF.

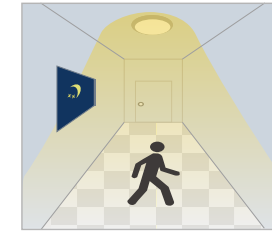

With insufficient daylight, when motion detected, light ON.

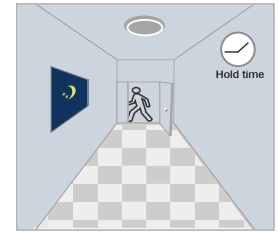

After the last detection and the present hold time elapsed, light OFF.

### 2. No daylight function

The daylight threshold is set to "Disable".

Light on when detect movement, After people leave, Light off after stand-by period.

Applications: Dim places such as Basement Parking, Underpass.



When motion is detected, the sensor will switch on the light to 100% brightness.

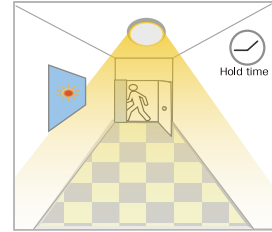

After people leave the detection area, light remains 100% brightness within hold time.

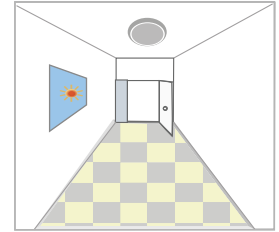

After the last detection and the present hold time elapsed, light OFF.

## Settings

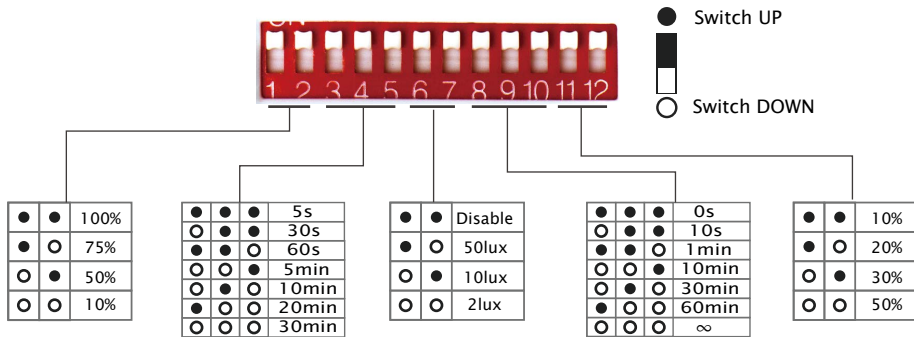

### Detection area

In this area, movement will be detected and able to trigger the sensor. 100% detection area is also known as the strong sensitivity.

### Hold-time

The period of light keeping 100% brightness after moving objects leave the detection area.

### Daylight threshold

Definition of the ambient brightness; only when the ambient brightness is lower than the preset specific lux amount, the sensor will work; when it's preset as "disable", the sensor works everytime it detects motion regardless the ambient brightness.

### Stand-by period

The period of light keeping low output before it's completely switched off. When it's preset as "∞", the light always keep at low output if no movement in the detection area and doesn't turn off.

### Stand-by dimming level

The definition of low output in the standby period.

### 3. Function Demo - Dimmable control/Corridor function

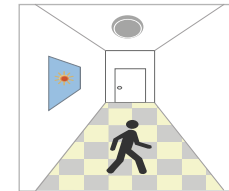

With sufficient daylight, even when motion detected, light remains OFF.



With insufficient daylight, when motion detected, light ON.

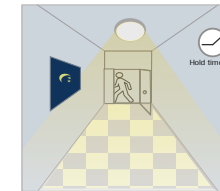

After last detection, the light will be dimmed down to the stand-by dimming level (10%,20%,30% or 50%) after holdtime.

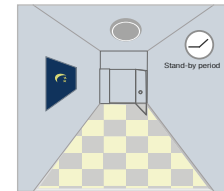

After the stand-by period, light OFF.

## Installation Method (Unit: mm)

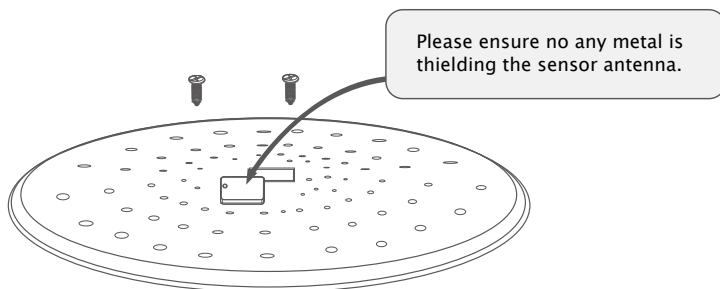
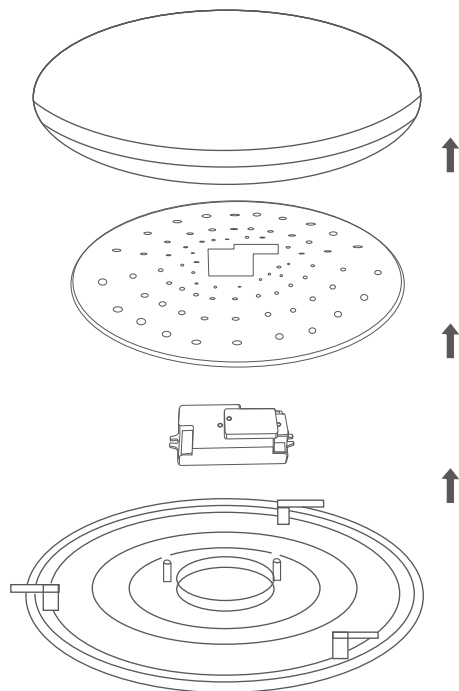

## Attention



1. Please read the instructions carefully before using this product and keep it well for all users to read at any time.
2. The sensor should be installed by qualified electrician and ensure power is off before the installation.
3. We reserve the right to modify any incorrect text, image and necessary technical parameters.
4. Any unauthorized modification is forbidden, otherwise all guarantees will be immediately invalid.

## Installation precautions

1. Microwave sensor can be installed in any lamp except the one with full metal shell.
2. The detected surface cannot be shielded by metal objects.
3. Make sure the microwave module is completely exposed outside.
4. The detection surface of the sensor module shall be installed facing the detection area.
5. Should be kept away from the driver to avoid interference generation and lamp flashing.
6. Wiring must be strictly in accordance with the wiring diagram to avoid short circuit.

## Application Environment

1. Suitable for indoor installation to avoid false triggering due to external factors such as rain, wind or tree swing.
2. Shall not be installed in the place with all four metal shelters and small space (such as galvanized-iron roof ).
3. Shall note be mounted installation, so as to avoid false trigger caused by the lamp itself shaking.
4. Shall not be installed next to large operating machines such as ventilator/ceiling fan to avoid false triggering caused by machine vibration.

## User Notes

1. Microwave can penetrate walls or glass thinner than 20cm and attenuate if thicker than 20cm.
2. The driver voltage shall be stable and float within 10%.
3. Detection area will be affected by speed of motion, mounting height and movement volume.
4. Conduct test on sunny days without the lampshade which will affect the tested lux value.